

Vectron International**Filter specification****TFS 1176A****1/5****Measurement condition**

Ambient temperature:	23	°C
Input power level:	0	dBm
Terminating impedance:		
Input:	50 Ohm	
Output:	50 Ohm	

Characteristics

Remark:

The maximum attenuation in the pass band is defined as the insertion loss a_e . The nominal frequency f_N is fixed at 1176,45 MHz without any tolerance or limit. The values of absolute attenuation a_{abs} are guaranteed for the whole operating temperature range. The frequency shift of the filter in the operating temperature range is included in the production tolerance scheme.

D a t a	typ. value		tolerance / limit	
Insertion loss	a_e	3,2 dB	max.	4,2 dB
Nominal frequency	f_N	-		1176,45 MHz
Passband	PB	-	$f_N \pm$	8,0 MHz
Pass band variation		1,0 dB	max.	2,0 dB
Absolute attenuation	a_{abs}			
1 MHz ...	1100 MHz	46	min.	40 dB
1100 MHz ...	1147 MHz	35	min.	28 dB
1196,91 MHz ...	1260 MHz	38	min.	28 dB
1260 MHz ...	1500 MHz	41	min.	40 dB
Group delay at f_N		37 ns	max.	50 ns
Group delay ripple within PB		30 ns	max.	40 ns
VSWR within PB		1,9 : 1	max.	2,3 : 1
Input power level		-	max.	15 dBm
Operating temperature range	OTR	-		+ 10 °C ... + 35 °C
Storage temperature range		-		- 40 °C ... + 85 °C
Temperature coefficient of frequency	TC_f **	-36 ppm/K		-

**) $\Delta f(\text{Hz}) = TC_f(\text{ppm/K}) \times (T - T_0) \times f_{T0}(\text{MHz})$

Generated:**Checked / Approved:**

Vectron International GmbH & Co. KG

Potsdamer Straße 18

D 14 513 TELTOW / Germany

Tel: (+49) 3328 4784-0 / Fax: (+49) 3328 4784-30

E-Mail: tft@vectron.com

Vectron International GmbH & Co. KG reserves the right to make changes to the product(s) and/or information contained herein without notice. No liability is assumed as a result of their use or application. No rights under any patent accompany the sale of any such product(s) or information.

Filter characteristic

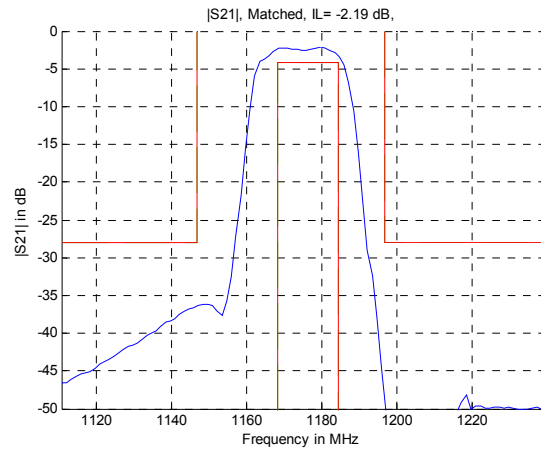
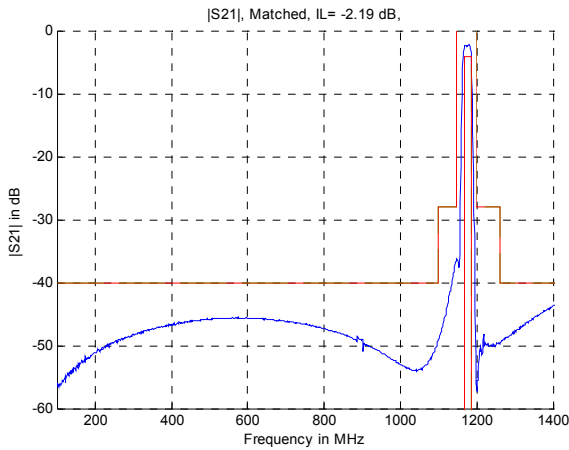

Construction and pin connection

(All dimensions in mm)

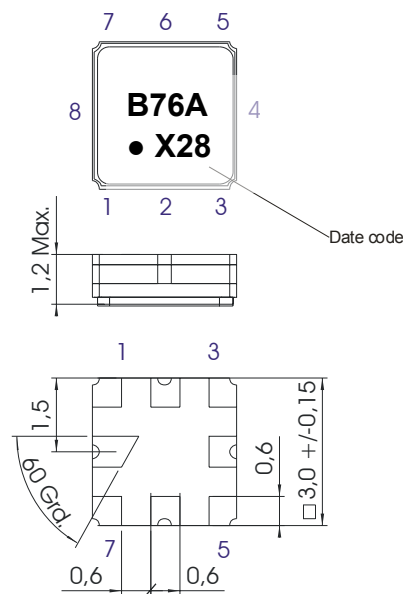

- 1 Ground
- 2 Input
- 3 Ground
- 4 Ground
- 5 Ground
- 6 Output
- 7 Ground
- 8 Ground

Date code: Year + week
 X 2009
 A 2010
 B 2011
 ...

50 Ω Test circuit

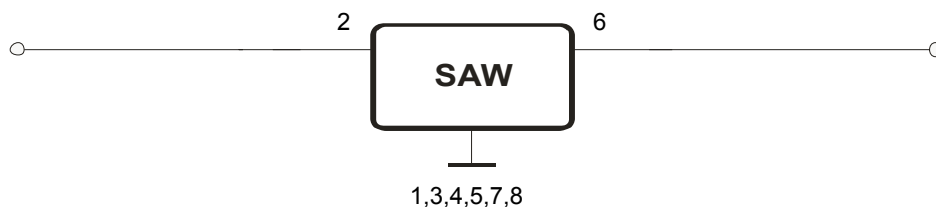

Vectron International GmbH & Co. KG
 Potsdamer Straße 18
 D 14 513 TELTOW / Germany
 Tel: (+49) 3328 4784-0 / Fax: (+49) 3328 4784-30
 E-Mail: tft@vectron.com

Vectron International GmbH & Co. KG reserves the right to make changes to the product(s) and/or information contained herein without notice. No liability is assumed as a result of their use or application. No rights under any patent accompany the sale of any such product(s) or information.

Stability characteristics, reliability

After the following tests the filter shall meet the whole specification:

1. Shock: 500g, 1 ms, half sine wave, 3 shocks each plane;
DIN IEC 68 T2 - 27
2. Vibration: 10 Hz to 500 Hz, 0,35 mm or 5 g respectively, 1 octave per min, 10 cycles per plan, 3 plans;
DIN IEC 68 T2 - 6
3. Change of temperature: -55 °C to 125°C / 30 min. each / 10 cycles
DIN IEC 68 part 2 – 14 Test N
4. Resistance to solder heat (reflow): reflow possible: three times max.;
for temperature conditions refer to the attached "Air reflow temperature conditions" on page 4;

This filter is RoHS compliant (2002/95/EG, 2005/618/EG)

Packing

Tape & Reel: IEC 286 – 3, with exception of value for N and minimum bending radius;
tape type II, embossed carrier tape with top cover tape on the upper side;

max. pieces of filters per reel: 9000
reel of empty components at start: min. 300 mm
reel of empty components at start including leader: min. 500 mm
trailer: min. 300 mm

Tape (all dimensions in mm)

- W : 8,00 ± 0,3
- Po : 4,00 ± 0,1
- Do : 1,50 +0,1/-0
- E : 1,75 ± 0,1
- F : 3,50 ± 0,05
- G(min) : 0,75
- P2 : 2,00 ± 0,05
- P1 : 4,00 ± 0,1
- D1(min) : 1,50
- Ao : 3,25 ± 0,1
- Bo : 3,25 ± 0,1
- Ct : 5,5 ± 0,1

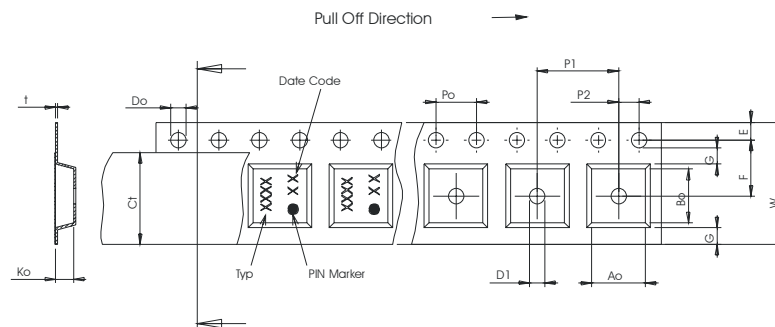

Reel (all dimensions in mm)

- A : 330
- W1 : 8,4 +1,5/-0
- W2(max) : 14,4
- N(min) : 50
- C : 13,0 +0,5/-0,2

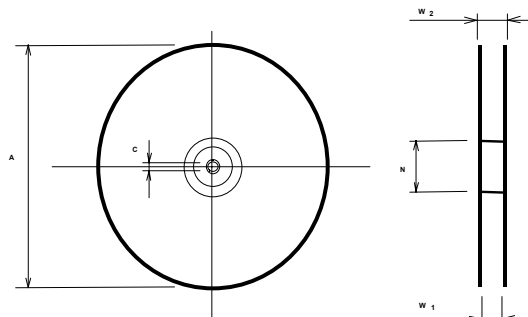

The minimum bending radius is 45 mm.

Vectron International GmbH & Co. KG
Potsdamer Straße 18
D 14 513 TELTOW / Germany
Tel: (+49) 3328 4784-0 / Fax: (+49) 3328 4784-30
E-Mail: tft@vectron.com

Vectron International GmbH & Co. KG reserves the right to make changes to the product(s) and/or information contained herein without notice. No liability is assumed as a result of their use or application. No rights under any patent accompany the sale of any such product(s) or information.

Air reflow temperature conditions

Conditions	Exposure
Average ramp-up rate (30°C to 217°C)	less than 3°C/second
> 100°C	between 300 and 600 seconds
> 150°C	between 240 and 500 seconds
> 217°C	between 30 and 150 seconds
Peak temperature	max. 260°C
Time within 5°C of actual peak temperature	between 10 and 30 seconds
Cool-down rate (Peak to 50°C)	less than 6°C/second
Time from 30°C to Peak temperature	no greater than 300 seconds

Chip-mount air reflow profile

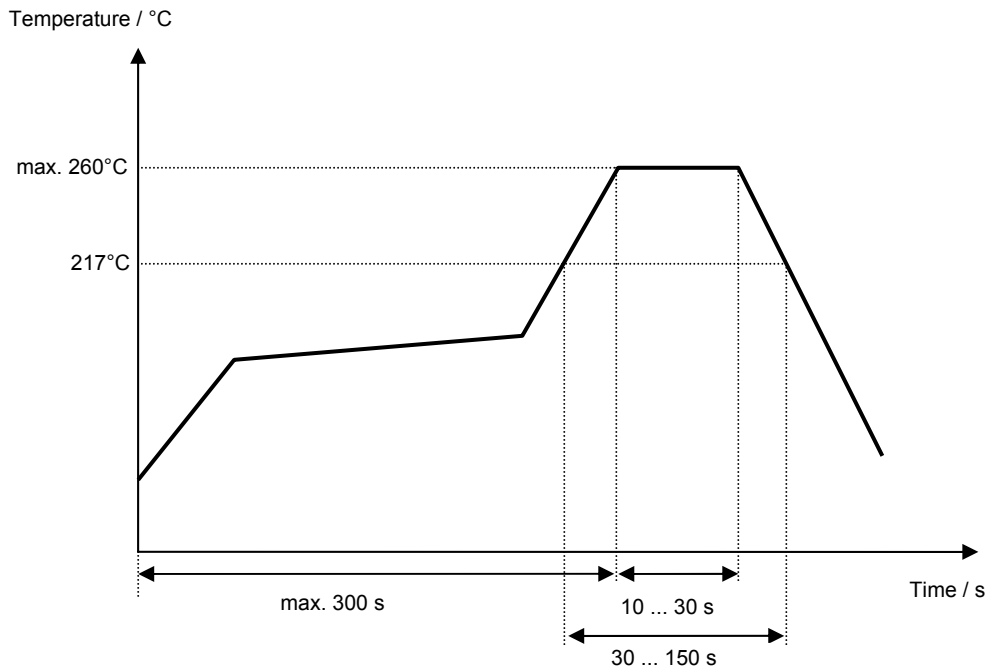

Vectron International GmbH & Co. KG
 Potsdamer Straße 18
 D 14 513 TELTOW / Germany
 Tel: (+49) 3328 4784-0 / Fax: (+49) 3328 4784-30
 E-Mail: tft@vectron.com

Vectron International GmbH & Co. KG reserves the right to make changes to the product(s) and/or information contained herein without notice. No liability is assumed as a result of their use or application. No rights under any patent accompany the sale of any such product(s) or information.

History

Version	Reason of Changes	Name	Date
1.0	- Generation of development specification	Alawneh	06.09.2006
1.1	- Change absolute attenuation	Strehl	15.09.2006
2.0	- Change data table - Added typical values - Generation of filter specification	Noack	26.07.2009
2.1	- Change test circuit - Update header and footer	Noack	03.12.2009